



# AquaTech Pressmain

## INSTRUCTIONS FOR

0. GENERAL SAFETY INFORMATION, WARNINGS & CAUTIONS
1. INSTALLATION
2. THE USER
3. SERVICING
4. DISPOSAL

### AQUAPACK (1-4)ET, SPILLPRESS SP(1-4), AQUASPILL SA10-E, GV-E, TA-E & AS (1-4) SERIES NITROPACK AS(1-4)-N PRESSURISATION UNITS WITH 2020+ CONTROLLER

**MODELS:** (1-4)ET45, (1-4)ET90; SP(1-4)ET; SA10-E,  
GV-E, TA-E, AS(1-4)ET/AV, AS(1-4)ET-N.



ISSUE: 14 1/04/10



Head Office: AGM House, London Rd, Copford, Colchester, Essex. CO6 1GT UK  
Tel: 01206 215121 Fax: 01206 215131

Manchester Office: Dolphin House, 130 Princess Road, Manchester M16 7BY  
Tel: 0161 226 4727 Fax: 0161 226 5848

## PRODUCT IDENTIFICATION

All units described in this manual are used to automatically maintain pressure in a pressurised heating or chilled water system.

Please note that the Serial Number “WNxxxxx” and model reference will be visible on the unit’s control panel fascia label and on the back page of the manual supplied with the unit.

Examples of units are shown below.



AquaPack 2ET45-P-500-E  
Pump unit & expansion vessel



AquaPack 2ET45-C1-E  
Cabinet unit with no vessel



500VR loose expansion vessel  
for installing with pump unit.



SpillPress SP2ET-P4-05-0-E  
with sealed spill vessel.



AquaSpill SA10-E



AquaSpill GV100-E, or AS2ET, open spill tank.









AquaSpill TA100-E with open  
Spill tank above pump unit.



NitroPack AS2ET-N with Nitrogen pressure vessel for HTHW  
High Temperature Hot Water heating system pressurisation.

# CONTENTS

	<b>0.0 GENERAL SAFETY INFORMATION</b>		<b>4</b>
0.1	 WARNINGS		4
0.2	 CAUTIONS FOR INSTALLATION		5
0.3	 CAUTIONS FOR OPERATION/USER		7
0.4	 CAUTIONS FOR MAINTENANCE		8
<b>1.</b>	<b>INSTALLATION INSTRUCTIONS</b>		<b>9</b>
1.1	GENERAL		9
1.2	ADDITIONAL WARNINGS & CAUTIONS		9
1.3	PROCEDURE		9
1.3.1	OFF-LOADING AT SITE		9
1.3.2	LOCATION		9
1.3.3	FIXING		9
1.3.4	PIPEWORK		10
1.3.5	EXPANSION, CONTROL and HYDRAULIC ACCUMULATOR VESSELS		12
<b>2.</b>	<b>USER INSTRUCTIONS</b>		<b>14</b>
2.1	CUSTOMER ASSURANCE		14
2.2	COMMISSIONING		15
2.3	OPERATING INSTRUCTIONS		15
2.3.1	ADDITIONAL WARNINGS & CAUTIONS		15
2.3.2	NORMAL OPERATION		16
2.3.3	SYSTEM WARNINGS		19
2.3.4	SYSTEM ALARMS		20
	REMOTE SIGNALS ON BMS ENHANCED MODELS ONLY		21
	RESETTING PARAMETERS		21
	SERVICING REMINDER		21
2.4	MAINTENANCE INSTRUCTIONS		22
2.4.1	ADDITIONAL CAUTIONS		22
2.4.2	PROCEDURE		22
<b>3.</b>	<b>SERVICING</b>		<b>23</b>
3.1	MAINTENANCE AND CARE OF YOUR EQUIPMENT		23
3.2	LEGAL REQUIREMENTS		23

3.3 SERVICE CONTACTS .....	23
<b>4. DISPOSAL.....</b>	<b>24</b>
<b><u>EC DECLARATION OF CONFORMITY</u> .....</b>	<b>24</b>
<b>OPERATING PARAMETERS.....</b>	<b>26</b>



## 0.0 GENERAL SAFETY INFORMATION



- These instructions are intended for the installer/operator/user/maintenance of this equipment and must be kept with the equipment, for the life of the equipment and made available to all persons. Please read GENERAL SAFETY INFORMATION 0.0, WARNINGS 0.1 and CAUTIONS 0.2, 0.3 & 0.4 before doing anything else, and then follow them carefully.
- The unit must only be installed/operated/used/maintained by a competent person; *A competent person is someone who is technically competent and familiar with safety practices and the hazards involved.*
- Hydraulic Accumulators/Expansion Vessels installed as part of/in conjunction with this equipment, with Pressure x Volume above 250 Bar-litres, require regular formal inspection by a *competent person*. This is a Legal Requirement under the “Pressure Systems Safety Regulations” (PSSR) and the Owner/User should be made aware of their responsibility for this. (see section 3. Servicing).
- Failure to install/operate/use/maintain the equipment as recommended below could cause damage to the equipment any anything subsequently connected to it, and invalidate the warranty provided by AquaTech-Pressmain to the buyer.
- Any damage caused to the equipment by misapplication, mishandling or misuse could lead to risk of **Electrocution, Burns, Fire, Flooding or injury to people or property** dependent upon the circumstances involved.
- This equipment contains moving/rotating parts that must remain guarded. Removal of or missing guards could lead to serious personal injury.
- This equipment automatically restarts after a power interruption.
- We accept no responsibility or liability for any consequences or damage/losses due to misapplication, mishandling or misuse of the equipment.
- It should be noted that the assembly of pressure equipment on site under the responsibility of the user (or his representative) is not subject to the Pressure Equipment Directive 97/23/EC. (National legislation covering assembly on site will apply)
- The latest version of this instruction manual with up to date safety information can be downloaded from our website at [www.aquatechpressmain.co.uk](http://www.aquatechpressmain.co.uk)



### 0.1 WARNINGS

- 0.1.1 **Do not touch any live parts for at least 5 minutes after switching off the electricity supply. Failure to observe this will constitute a severe Electric shock and/or Burns hazard and may be lethal.**
- 0.1.2 **The equipment is only suitable for earth referenced supplies and must be permanently earthed to avoid Electric shock hazard.**

- 0.1.3 With equipment isolator OFF, mains voltage may still be present from BMS system. This constitutes an Electric shock hazard.
- 0.1.4 Emergency stop button does not remove dangerous voltages from control panel/pump motor assemblies. This constitutes an Electric shock hazard.
- 0.1.5 Metal parts (e.g. heat sinks) may reach temperatures of 90 degrees centigrade and will constitute a Burns hazard.
- 0.1.6 Some equipment is designed to operate with liquid temperatures up to 200 degrees centigrade and will constitute a Burns/scalding hazard.
- 0.1.7 The equipment must not be pressurised beyond the maximum working pressure as stated on pumps/pipework/vessels/control panel otherwise serious mechanical damage/destruction could occur causing injury to people or property.
- 0.1.8 The equipment must not be heated/chilled beyond the maximum/minimum working temperature as stated on pumps/pipework/vessels/control panel otherwise serious mechanical damage/destruction could occur causing injury to people or property.
- 0.1.9 Any damage to equipment, pumpset, vessels, pipework or system components caused by misapplication, mishandling or misuse could lead to Electric shock hazard, Burns hazard, Fire hazard, Flooding hazard or cause injury to people or property.
- 0.1.10 This equipment may contain moving/rotating parts that must remain guarded. Removal of or missing guards could lead to serious personal injury.
- 0.1.11 Pressure vessels must never be disassembled whilst in use, they contain high pressure air/gas charge which could cause injury to people or property.
- 0.1.12 Pump motors with lifting eyes; the lifting eyes are only suitable for lifting motors NOT the entire pump assembly. This could cause injury to people or property.
- 0.1.13 Ensure the base/foundation/plinth/wall to which the equipment is to be attached is sufficiently strong enough to carry the entire mass of the equipment including the water that it will contain under worst-case fault conditions. E.g. fully saturated pressure vessel with no air charge, break tank full to overflowing, etc. Failure to observe this could cause serious mechanical damage/destruction resulting in injury to people or property.



## 0.2 CAUTIONS FOR INSTALLATION

- 0.2.1 READ GENERAL SAFETY INFORMATION 0.0, WARNINGS 0.1 and CAUTIONS 0.2, 0.3 & 0.4
- 0.2.2 The unit should only be installed/operated by a competent person; *A competent person is someone who is technically competent and familiar with safety practices and the hazards involved.*
- 0.2.3 Do not lift the pumpset by pipework. Lift the pumpset by the container pallet using a pallet/forklift or crane by passing strops underneath the skid using a spreader bar. Failure to utilise these facilities will result in damage to the pumpset.
- 0.2.4 Store in a dry place to avoid damp conditions deteriorating the equipment.
- 0.2.5 Protect against dirt, damage and frost. It is absolutely essential that no foreign matter such as pipe thread swarf, welding slag, grit or stones are allowed to enter the equipment. Debris of this type can cause severe damage to the mechanical seals, diaphragms and impeller. Frost/freezing will damage pumps/pipework and control panel components.
- 0.2.6 The equipment is only suitable for installation in a clean, dust free indoor environment, with adequate protection from heat and frost, and sufficient ventilation to ensure cooling of the motors. Ambient air temperature should be between 5 and 40 degrees centigrade, non-condensating. Operation outside of these conditions could seriously damage the equipment.
- 0.2.7 If the equipment were to be stored or taken out of service for a period of time (e.g. 1 week or more), then we would recommend draining the equipment of all water/liquid (with due regard to any local regulations) to prevent frost damage to components. When restarting is required we would recommend commissioning by our authorised service agent.



- 0.2.8** Ensure the base/foundation/plinth/wall to which the equipment is to be attached has sufficient mass compared to the equipment, in order to avoid noise/vibration transmission. E.g. the mass of the base should be at least five times the mass of the equipment.
- 0.2.9** Ensure the electrical supply is the correct voltage, current, frequency and type for the equipment supplied and that suitable circuit protection equipment is installed in the supply. Incorrect electrical installation could be an electric shock/burns/fire hazard.
- 0.2.10** When accessing the control panel to make electrical connections adopt anti-static procedures e.g. wear anti-static earthed wristband, to avoid risk of damaging the controller.
- 0.2.11** All products that are packaged to include Pressure vessel(s)/Hydraulic Accumulator(s)/Expansion Vessel(s) are classed as “Assemblies” under the Pressure Equipment Directive (PED). Where units are despatched with “Loose” vessel(s) for assembly on site it is absolutely essential that they be installed as detailed in the instructions using the fittings provided where appropriate. Failure to observe this will nullify compliance with the PED and may present a safety hazard. Your warranty may also be affected.
- 0.2.12** Where Hydraulic Accumulator(s)/Expansion Vessel(s) are supplied as a loose item, they must be installed/connected correctly before operating the equipment; otherwise serious damage from over-pressure/pump overheating could occur.
- 0.2.13** Do not operate this equipment/pumpset prior to commissioning (section 2.2) This could cause irreparable damage to equipment/pumpset/pipework/system components.
- 0.2.14** Isolate the equipment/pumpset before pressure testing system. Excess pressure could irreparably damage the pressure transducer, pressure switches (where fitted) and the diaphragms of pressure vessel/hydraulic accumulators.
- 0.2.15** It is the installers’ responsibility to ensure subsequent pipework etc can accept the pressures generated by the equipment/pumpset and to install an overpressure safety device into the system with due respect to the suction pressure present on the pumpset, the pump closed valve pressure stated on the pump, the maximum working pressure stated on any of the attached pressure vessels and any other device connected to the system e.g. boilers, calorifiers etc.
- 0.2.16** When chlorination of the system is carried out, ensure that any residual chlorine is removed by thorough flushing as detailed in the HSE approved code of practice L8, to avoid damaging the equipment/pumpset. The normal level of chlorination is up to 2 parts per million (ppm), but shock dosing for sterilization purposes, at 25-50 ppm for 24-48 hours is acceptable as long as all chlorine is removed once the process is complete. Chlorination beyond these limits could seriously damage pumpset components and WILL NOT be covered by the warranty.
- 0.2.17** The installer/user is responsible for the installation of the correct earthing and protection according to valid national and local standards. All operations must be carried out by a suitably qualified person.
- 0.2.18** The equipment is only suitable for earth referenced supplies and must be permanently earthed to avoid electric shock hazard.
- 0.2.19** The equipment must be permanently earthed with appropriate sized Earthing.
- 0.2.20** Equipment containing variable speed drives/motors has high earth leakage current >3.5mA and will require additional earth bonding whereby a single conductor of increased size or duplicate earth conductors must be provided.
- 0.2.21** Never perform high voltage resistance tests on control panels, variable speed drives/motors without first disconnecting the panel/drive/motor from the circuit being tested as this will damage the built in electronic components.
- 0.2.22** Equipment containing variable speed drives/motors that has been stored/not powered up for long periods of time (i.e. 1 year or more) may require the variable speed drive/motor capacitors to be reformed. Please contact AquaTech-Pressmain for more information. Failure to reform capacitors will result in drive/motor damage.
- 0.2.23** Metal parts (e.g. heat sinks) may reach temperatures of 90 degrees centigrade.
- 0.2.24** RCD’s/ELCB’s are not recommended for use with variable speed drives/motors. Where their use is mandatory use type B RCD’s. For single phase equipment with inverter motors the earth leakage circuit breaker must trip out when earth fault currents with DC content (pulsating DC) occur. For three phase equipment with inverter motors the earth leakage circuit breaker must trip out when earth fault currents with DC content (pulsating DC) and smooth DC earth fault currents occur.
- 0.2.25** RCD’s/ELCB’s suitable for use with variable speed drives/motors are not suitable for personnel protection.

- 0.2.26** EMC – inverter motors 0.37kW to 5.5kW Electromagnetic disturbance – first environment (residential areas) – unrestricted distribution, corresponding to CISPR 11, class B, group 1. Inverter motors > 5.5kW Electromagnetic disturbance – first environment (residential areas) – restricted distribution. Immunity to Electromagnetic disturbance – second environment (industrial areas) – unrestricted distribution, corresponding to CISPR 11, class A, group 1. Inverter motors > 5.5kW for installation in first environment (residential areas) require additional EMC filter to obtain class B, group 1 status.
- 0.2.27** EMC - With respect to BS EN61000-3-2 this equipment is defined as 'professional equipment' and therefore the installer/user may need to seek permission from the supply utility to connect this equipment to the public low voltage mains supply.
- 0.2.28** Do not use the "Pressurisation unit" for filling the system pipework. These types of equipment are only suitable for topping up small losses/leaks in the system. A separate means of filling e.g. a quick fill loop (check with local water regulations first!) should be used instead, with the system connection valve to the equipment closed.
- 0.2.29** Where "Expansion vessels" are used on LTHW heating system pressurisation units, the temperature of the fluid returning to the vessels should not exceed 70 degrees Centigrade as this could damage the vessel diaphragm. Where the temperature exceeds 70C an intermediate cooling vessel should be fitted.
- 0.2.30** For MTHW and HTHW pressurisation units use a Nitrogen vessel suitable for the system conditions. Please contact AquaTech-Pressmain for further information.
- 0.2.31** Do not use the "Pressurisation unit" for dosing the system with chemicals. Only allow clean cold water into the break tank. Anything other than clean cold water could damage the pumps/pipework components.
- 0.2.32** Drain cocks/valves and air bleed screws must not be left open as this could cause flooding.



### 0.3 CAUTIONS FOR OPERATION/USER

- 0.3.1** READ GENERAL SAFETY INFORMATION 0.0, WARNINGS 0.1 and CAUTIONS 0.2, 0.3 & 0.4
- 0.3.2** The unit should only be operated/used by a competent person; *A competent person is someone who is technically competent and familiar with safety practices and the hazards involved.*
- 0.3.3** The Owner/User of this equipment has a Legal Responsibility to ensure that it is subject to regular formal inspections. See Section 3. Servicing, for details.
- 0.3.4** Where Hydraulic Accumulator(s)/Expansion Vessel(s) are supplied as a loose item, they must be installed/connected correctly before operating the equipment, otherwise serious damage from over-pressure could occur.
- 0.3.5** The equipment must not be run until commissioned by an authorised AquaTech-Pressmain agent, this could irreparably damage the pump equipment and/or system components/pipework connected to it.
- 0.3.6** The pumpset should be left switched ON with the pumps switched to AUTO for normal operation.
- 0.3.7** The pumpset should not be left in "Hand" operation for more than 1 minute. This could lead to severe damage of pumpset components and/or pipework system from over-pressure and/or overheating.
- 0.3.8** Ensure pumpset has an adequate water supply at all times to prevent dry running causing pump seal damage and water leakage.
- 0.3.9** Do no attempt to start pumps without liquid in volutes (pumps must be fully primed); mechanical seals must have a film of liquid between faces for proper operation and to prevent damage.
- 0.3.10** Portable telephones or other electro-magnetic equipment must not be used near the equipment to avoid corruption of program and unpredictable operation of unit.
- 0.3.11** For Pressurisation units utilising Nitrogen Vessels (generally HTHW units) ensure there is an adequate supply of Nitrogen at all times to avoid mis-operation of the equipment.



## 0.4 CAUTIONS FOR MAINTENANCE

- 0.4.1 READ GENERAL SAFETY INFORMATION 0.0, WARNINGS 0.1 and CAUTIONS 0.2, 0.3 & 0.4
- 0.4.2 The unit should only be operated/maintained by a competent person; *A competent person is someone who is technically competent and familiar with safety practices and the hazards involved.*
- 0.4.3 Where the pumpset is fitted with Building Management Services (BMS) interconnections, notify the appropriate persons before switching OFF for maintenance or adjustments, to avoid unnecessary alarm conditions occurring. WARNING: With pumpset isolator OFF, mains voltage may still be present from BMS system. This constitutes an Electric shock hazard.
- 0.4.4 To prevent seizing, pumpsets must not be left unused for long periods (e.g. 1 week).
- 0.4.5 The pumps must be run regularly to avoid stagnation of water in the pumps/pipework (e.g. daily).
- 0.4.6 Do not vent air from air valves on vessels. These are for adjustment of pre-set cushion pressures. If wrongly adjusted this will lead to incorrect operation of the pumpset and possible damage to pumps, pipework and system components from overheating and over-pressure.
- 0.4.7 Switch OFF pumpset before accessing pumps and/or control panel.



# 1. INSTALLATION INSTRUCTIONS

## FOR PRESSURISATION UNITS with 2020Plus CONTROL: SERIES AQUAPACK, SPILLPRESS, AQUASPILL & NITROPACK;

### 1.1 GENERAL

These instructions are intended for the installer of this pressurisation unit. Please follow them carefully.

The unit should only be installed by a competent person; *A competent person is someone who is technically competent and familiar with safety practices and the hazards involved.*

It should be noted that the assembly of pressure equipment on site under the responsibility of the user (or his representative) is not subject to the Pressure Equipment Directive 97/23/EC. (National legislation covering assembly on site will apply).

Failure to install the equipment as recommended below could invalidate the warranty provided by AquaTech-Pressmain to the purchaser.

### 1.2 ADDITIONAL WARNINGS & CAUTIONS

- 1.2.1 ON UNITS WITH VARIABLE SPEED/INVERTER DRIVES/MOTORS - DO NOT TOUCH ANY LIVE PARTS FOR AT LEAST 5 MINUTES AFTER SWITCHING OFF THE POWER. Failure to observe this will constitute an ELECTRIC SHOCK HAZARD.
- 1.2.2 READ GENERAL SAFETY INFORMATION 0.0, WARNINGS 0.1 and CAUTIONS 0.2, 0.3 & 0.4
- 1.2.3 SA10-E: Standard units are supplied in two pieces, the control module and spill tank combined as one piece, and the pressure vessel as a separate item. The pressure vessel screws into the fitting provided on the top of the spill tank framework.
- 1.2.4 SA10-E: There is a valve situated just above the pump discharge port **DO NOT** interfere with this valve. The valve has been pre-set at the factory and locked off in the correct position to ensure the pump operate to the correct efficiency of the unit.

### 1.3 PROCEDURE

#### 1.3.1 OFF-LOADING AT SITE

**Do not lift unit by pipework.** Lift the unit by the container pallet using a pallet/forklift or crane by passing strops underneath the skid using spreader bar. Failure to utilise these facilities could result in damage.

#### 1.3.2 LOCATION

The pressurisation unit should be connected to the underside of the return header on the suction side of the circulating pump, but not within any influences from the circulating pump.

If the equipment is to be installed in an unheated room, ensure that there is adequate frost protection. On a heating system do not lag any expansion vessel or its connection to the system. This can result in damage occurring.

Ensure that location for pumpset provides adequate clear space to accommodate unit with reasonable access to all parts; AquaTech-Pressmain recommend a minimum distance of 500mm. There must be sufficient room to:-

fully open control panel door; withdraw diaphragms from vessels, repair or replace pumps.

**Should any of these location conditions not be satisfied AquaTech-Pressmain Limited reserve the right to charge labour on any warranty work required on the pumpset.**

#### 1.3.3 FIXING

Install the equipment on a flat, even and level surface, where practical on a raised plinth to keep equipment above damp floor. Locate unit in position. If necessary level the base by inserting packing strips adjacent to bolt positions. Firmly attach unit to base.

### 1.3.4 PIPEWORK

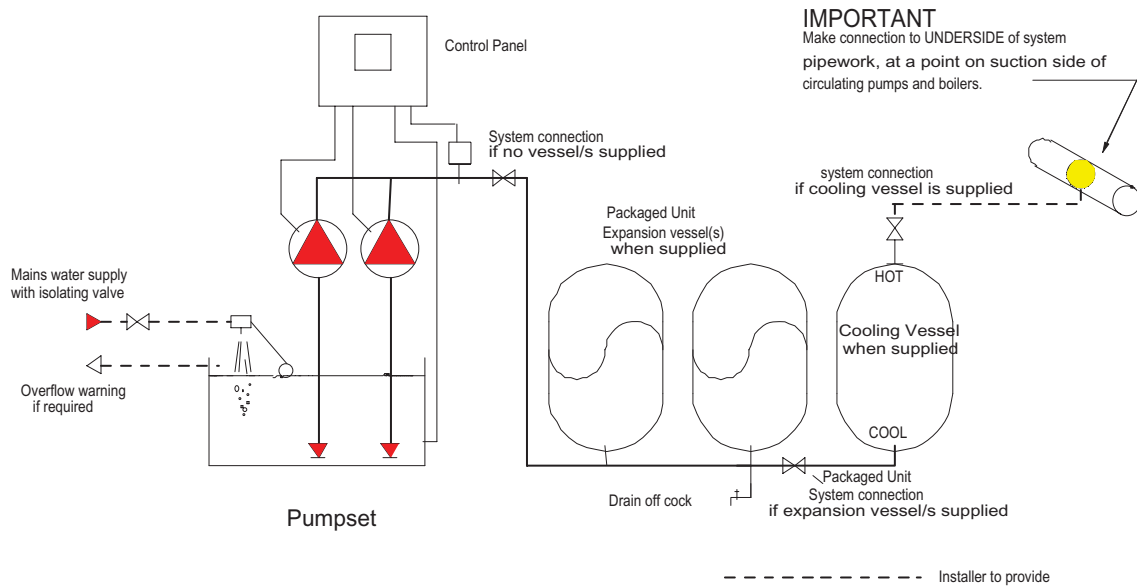

**Fig 1.1 Pipework layout for AQUAPACK UNIT (model shown 2ET45)**

#### 1.3.4.1 Mains Water Supply

- i. Fit an isolating valve in the supply to enable the unit to be isolated from the supply for maintenance.
- ii. Connect the supply. For Aquapack cabinet models this is a ½" BSP male connection at the side of the cabinet. For other Aquapack models the unit is supplied with a ½" BSP medium pressure float valve, fittings, support, fixings and lid in the breaktank. For Spillpress, Aquaspill and Nitropack models ¾" BSP float valve or larger. Assemble these to suit, to provide a Type AA air gap if required, and to satisfy any local water regulations.
- iii. To maintain an adequate supply of water to the breaktank the float valve size needs to be matched to the supply pressure. The Aquapack unit is supplied with a medium pressure float valve insert (0.187" orifice). To increase the flow fit a low-pressure insert (0.375" orifice), available on request.
- iv. For Spillpress, Aquaspill and Nitropack units the Mains water supply should be 1 bar min.

#### 1.3.4.2 System Connection

- i. The unit must be connected with any expansion vessels and cooling vessels, to the underside of the return header on the suction side of the circulating pumps and boiler/chiller (see Location 1.3.2.)
- ii. The system connection on the pressurisation unit is to a lockshield isolating valve.
- iii. If no expansion vessels are supplied, connection is at the discharge of pumps or for cabinet models the side of the cabinet. If expansion vessel/s are supplied, connection is at base of the expansion vessel. If a cooling vessel is supplied, connection is on the top (hot side) of the cooling vessel.
- iv. All hydraulic accumulators and expansion vessels fitted to the system must have isolating and drain off valves to enable them to be serviced, as well as removable pipework to enable bladders to be changed.

#### 1.3.4.3. Nitrogen Supply for Model AN2ET only:

- i. A Nitrogen cylinder with regulator must be connected to the solenoid valve on the nitrogen/water control vessel to provide a nitrogen charge to the vessel. This supply must be over-pressure protected by the supplier/installer of the nitrogen equipment, so that even in the event of complete regulator failure; the supply pressure cannot exceed the maximum working pressure rating of the nitrogen/water control vessel. Also ensure a non-return valve is fitted in the nitrogen supply line so that in the event of empty nitrogen vessel, system water is not allowed to enter the nitrogen bottle.

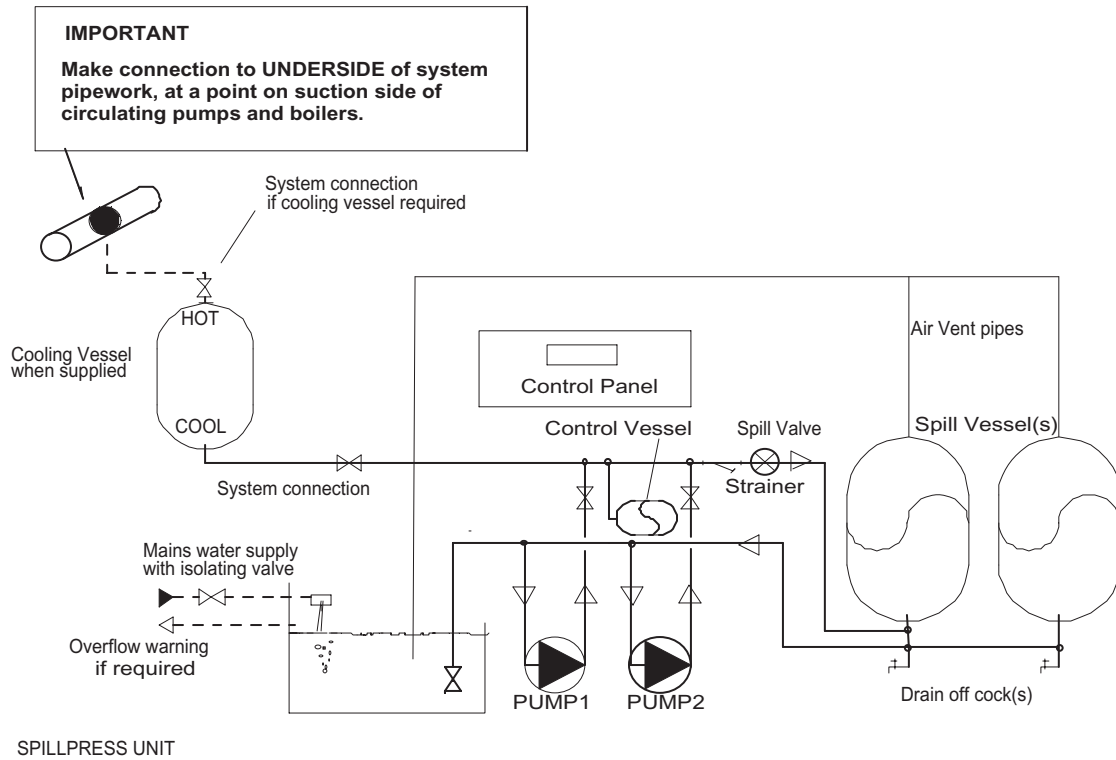

Fig 1.2 Pipework layout for SPILLPRESS UNIT (model shown SP2ET)

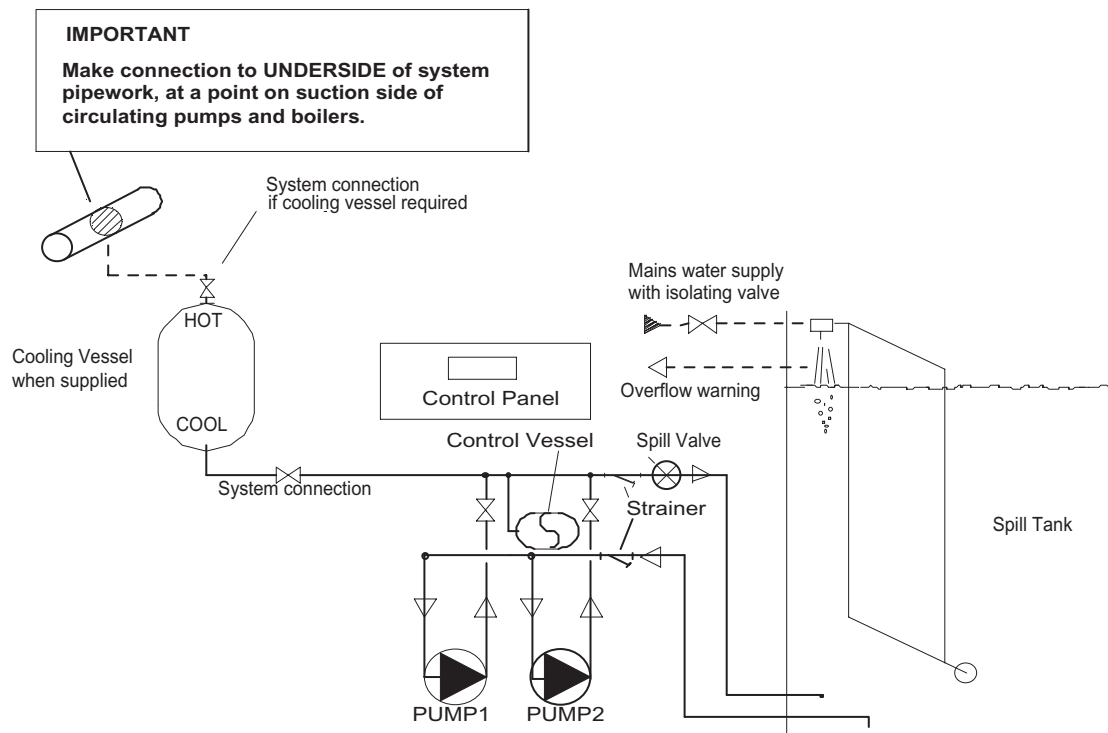

Fig 1.3 Pipework layout AQUASPILL UNIT (model shown AS2ET)

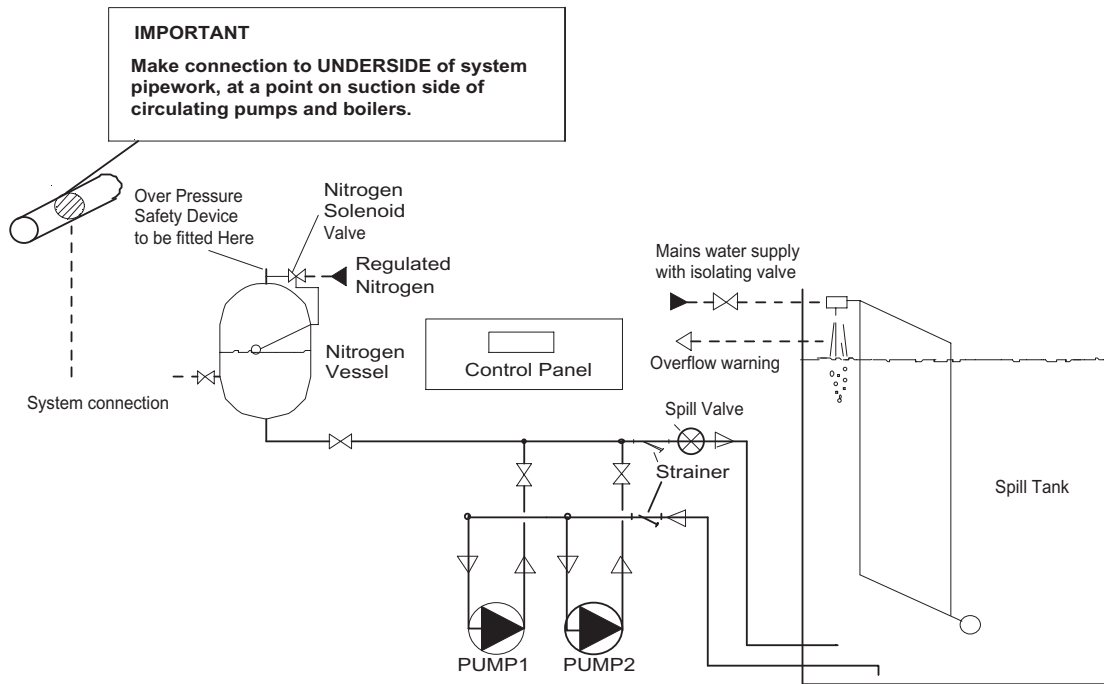

Fig 1.4 Pipework layout NITROPACK UNIT (model shown AS2ET-N)

### 1.3.5 EXPANSION, CONTROL and HYDRAULIC ACCUMULATOR VESSELS

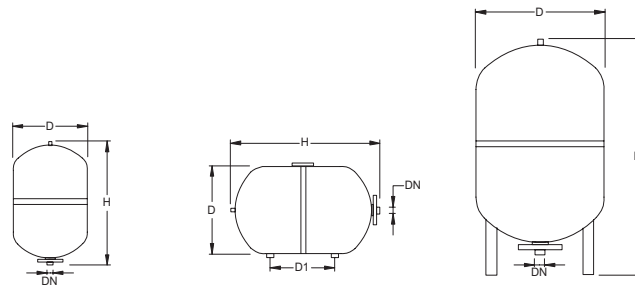

Fig 1.5 8 RS

25 HR

60 VR - 500 VR

Type	8 RS	25 HR	60 VR	100 VR	200 VR	300 VR	500 VR
Nominal Content –litres	8	25	60	100	200	300	500
D mm	206	295	409	480	634	634	740
D1 mm	-	228	-	-	-	-	-
H mm	320	485	740	840	980	1280	1485
Water Connection DN BSP	¾"	1"	1"	1"	1 ¼"	1 ¼"	1 ¼"
Weight Kg	2.4	5.6	25	32	50	55	85
Max. working Pressure-bar	10	10	10	10	10	10	10

All vessels must be securely mounted to prevent any movement from imposing strain on the attached pipework. Vessels of 60 litres capacity or greater **MUST** be mounted vertically on the integral legs with water connection lowermost.

Set up the vessel so the air charge filling valve (top) and the diaphragm (bottom) are accessible for future maintenance. All vessels must have isolating and drain off valves fitted to enable them to be serviced. The connecting pipework should be removable to give access for replacing the diaphragm and should be the same size as the vessel connection to minimise friction losses.

Set the air cushion pre-charge pressure (see 2.4.2 Maintenance Procedure for details) to the correct level, dependent on the application required for the vessel. Refer to the Operating parameters at the back of this manual or Aquatech-Pressmain for advice.

### 1.3.6 ELECTRICAL

READ GENERAL SAFETY INFORMATION 0.0, WARNINGS 0.1 and CAUTIONS 0.2, 0.3 & 0.4

1.3.6.1 All wiring must comply with the latest edition of local wiring Regulations.

1.3.6.2 **Wear anti-static wrist strap at all times** to avoid static discharge causing problems with the built in electronic program.

1.3.6.3 Connect incoming electrical mains supply to identified terminals in panel (see fig. 1.6). Ensure voltages and frequency indicated on the motor nameplates and wiring diagrams correspond with supply mains data and that the supply fuse ratings are correct for the total current rating of the equipment. Note: some units require a 3 Phase supply for larger applications. Refer to wiring diagram supplied with the unit or contact AquaTech-Pressmain.

1.3.6.4 Make any BMS connections required to terminals A-Z on Interface card inside control panel. Connect boiler/chiller terminals nos. X,Y,Z on interface card in series with the boiler/chiller control circuits so that in the event of a fault condition occurring the boiler/chillers shut down and remain inoperative until the fault condition is rectified. A typical arrangement is shown in fig 1.7.

1.3.6.5 Complete any required earth bonding.

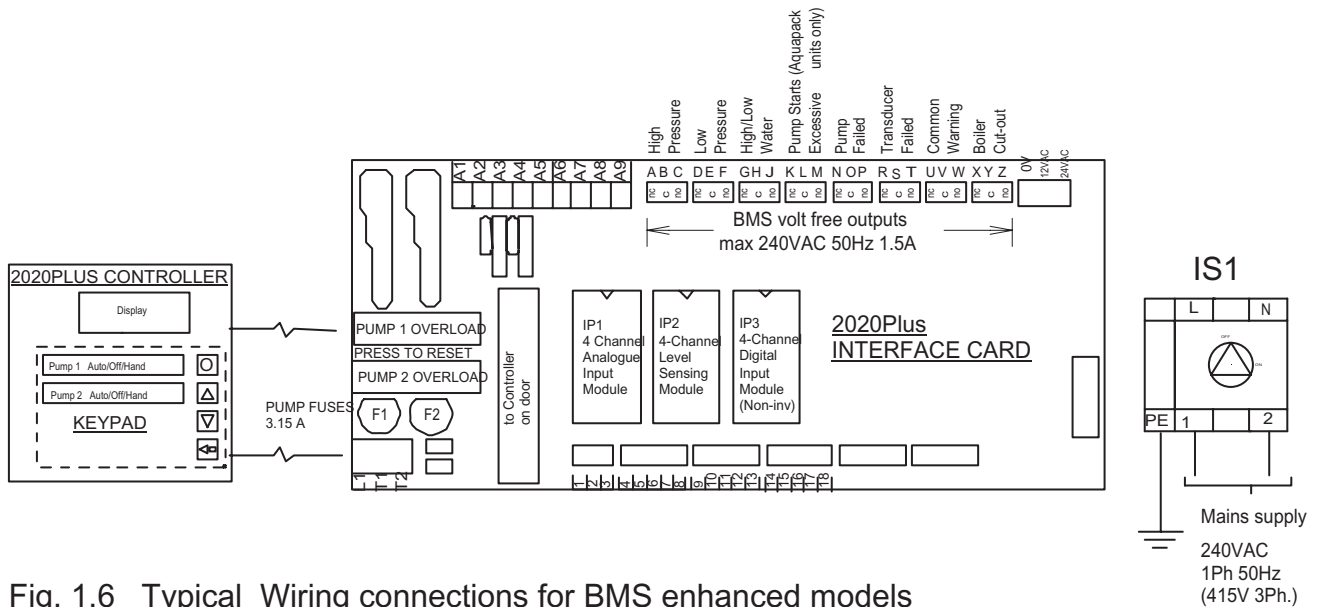

Fig. 1.6 Typical Wiring connections for BMS enhanced models

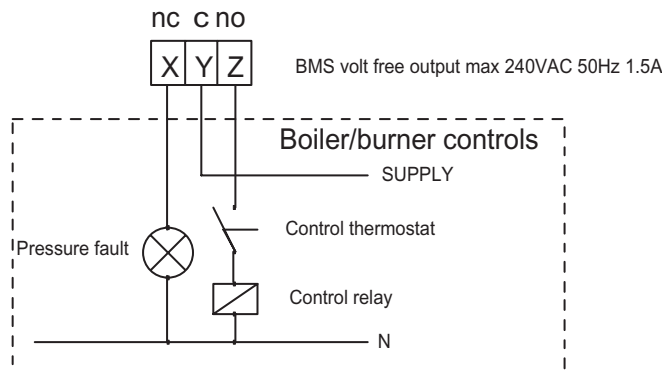

Fig 1.7 Typical Boiler Interrupt Circuit (wiring by others)



## 2. USER INSTRUCTIONS

### 2.1 CUSTOMER ASSURANCE

**AQUATECH-PRESSMAIN ASSURE YOU THAT IF ANY PART OF THIS EQUIPMENT BECOMES DEFECTIVE DUE TO FAULTY MANUFACTURE OR MATERIALS WITHIN 12 MONTHS FROM THE DATE OF INVOICE OR 12 MONTHS FROM DATE OF COMMISSIONING BY AUTHORISED AQUATECH-PRESSMAIN AGENT, THE PART WILL BE REPAIRED OR REPLACED.**

The only conditions are: -

- ◆ The equipment must have been installed, operated and maintained as recommended by **AquaTech-Pressmain Ltd.**
- ◆ The equipment must not have been neglected, misused, modified, or used for any other purpose than its original application.
- ◆ The commissioning should be carried out within 6 months of the date of invoice by an authorised **AquaTech-Pressmain Ltd** agent.
- ◆ This Assurance does not apply to those items not supplied by us or to defects arising from parts not made or approved by **AquaTech-Pressmain Ltd**. The individual manufacturer's own policies for dealing with defects will apply.
- ◆ Any part repaired or replaced under these Assurances will be covered for the balance of the appropriate Assurance period.
- ◆ If we have any disagreement about these Assurances which we are unable to resolve we will both abide by the decision of an agreed Arbitrator or, if we are unable to agree, one appointed by the Heating and Ventilating Contractors Association (HVCA) Arbitration Scheme Rules.
- ◆ These Assurances are in addition to, and do not detract from, the contractual rights you have under Statute or at common law.

**For full details please see the AquaTech-Pressmain Ltd "CONDITIONS OF SALE"**

## 2.2 COMMISSIONING

Whilst this equipment has been tested in the factory to the required settings (detailed in operating parameters at the back of instruction manual), it is impossible to simulate the actual on-site conditions, especially if they are unusual. Also, the settings may have been disturbed since leaving the factory. Therefore we strongly recommend **the equipment is commissioned by our authorised agent** who will prepare the equipment, make any necessary adjustments and leave the equipment in operational order.

Commissioning also enhances the Warranty (see Customer Assurance)

Prior to requesting an engineer to attend the site for commissioning, the client must ensure that;

- the equipment has been correctly installed;
- a written scheme of examination has been obtained where required under the Pressure Systems Safety Regulations;
- an adequate water supply and permanent electricity supply are available;
- the equipment and pipework in the building being served by the pressurisation unit is capable of accepting the generated pressures.

## 2.3 OPERATING INSTRUCTIONS

### FOR PRESSURISATION UNITS with 2020Plus CONTROL SERIES - Aquapack, Spillpress, Aquaspill & Nitropack

**Standard units are used for maintaining the pressure in pressurised heating systems**  
**Aquapack units: sealed heating systems up to 30,000L and chilled systems up to 200,000L.**  
**Spillpress units: sealed heating systems up to 70,000L and chilled systems up to 250,000L.**  
**Aquaspill SA10-E units: sealed heating systems up to 12,600 litres and chilled systems up to 72,000 litres.**  
**Aquaspill units: heating systems up to 300,000L and chilled systems up to 1,000,000L.**  
**Nitropack units: heating systems up to 300,000L with temperatures up to 200 deg.C**  
**Larger systems are catered for by special units, please see any relevant appendices**

READ GENERAL SAFETY INFORMATION 0.0, WARNINGS 0.1 and CAUTIONS 0.2, 0.3 & 0.4

### 2.3.1 ADDITIONAL WARNINGS & CAUTIONS

- 2.3.1.1 Isolate the pressurisation unit from the system before pressure testing** to avoid possible damage to transducer and expansion vessels.
- 2.3.1.2 SA10-E:** There is a valve situated just above the pump discharge port **DO NOT** interfere with this valve. The valve has been pre-set at the factory and locked off in the correct position to ensure the pump operate to the correct efficiency of the unit.
- 2.3.1.3 On Model AS(1-4)ET-N only: ensure there is an adequate Nitrogen supply to the control vessel at all times**

### 2.3.2 NORMAL OPERATION

The pressurisation unit automatically maintains a minimum set pressure in a heating or chilled system by transferring make-up liquid from a breaktank, spilltank or sealed spill vessel into the system. When the system pressure falls below the required level the Duty pump automatically refills the system until the pressure is restored. If the Duty Pump fails to maintain the required pressure the Support pump will operate in addition to the Duty Pump.

The control is by AquaTech-Pressmain 2020Plus Microprocessor, with a 2-line display on the control panel, showing the current system pressure and status.

When switched on the display shows,  
then self checks, flashing all LED lights on keypad,

AQUATECH 2020Plus V2.00  
PRESSMAIN

and identifies configuration for pump operation  
(e.g. "ET45" pressurisation unit)

ET45

followed by the system status and pressure

PRESSURE SYSTEM IS O.K.  
Pressure ..... bar

For "normal" operation, all Hand/Off/Auto switches should be left in "Auto", all pump suction and discharge valves should be left open, all hydraulic accumulator/expansion vessel isolating valves should be left open, and drain cock/valves should be left closed. Should it be necessary to have a situation that is not "normal" operation, then we would strongly recommend attendance to site by our trained/authorised service personnel. Please contact AquaTech-Pressmain for more details.

#### Pump Operation

##### **Sealed system pressurisation unit; "2ET45" & Dual System "2ET45-DS" Models:**

The pressurisation unit automatically maintains a minimum set pressure in a heating or chilled system by transferring make-up liquid from a breaktank, into the system. When the system pressure falls below the required level the Duty pump automatically refills the system until the pressure is restored. If the Duty Pump fails to maintain the required pressure the Support pump(s) will operate in addition to the Duty Pump. "Dual system" (DS) models pressurise two independent systems that are isolated from each other via solenoid valves. When system 1 or 2 requires topping up, the appropriate solenoid valve opens and the duty/support pumps operate as required. Operating pump 1 in "hand" forces solenoid valve for system 1 to open, operating pump 2 in "hand" forces solenoid valve for system 2 to open, valves automatically return to auto operation when pumps are no longer run in "hand". It is also possible to open or close a system solenoid valve manually by pressing and holding the appropriate button on the control panel only when a pump is run in "hand".

##### **Heating system pressurisation unit; Spillpress "SPxET", Aquaspill "SA10-E, GV-E, TA-E, ASxET, ASxAV" & Nitropack "ASxET-N" Models: (where "x" is the number of pumps)**

Operation as for 2ET45 above except these units are for larger systems have a spill valve(s) which opens at a predetermined pressure whilst water is expanding and raising the pressure in the control vessel. Once opened the spill valve(s) allows water to pass into the sealed spill vessel(s) or spilltank(s). The system pressure falls until it reaches the cut-off point of the spill valve(s). This operation continues during the period of raising the system temperature. During a fall in the system temperature the contents contract and allow the system pressure to fall. The system pressure is made up by the Duty pump returning water to the system from the sealed spill vessel(s) or spilltank(s). In the event of insufficient water being available in the spill vessel/spilltank, which can normally be attributed to losses from the system, the pump will draw water from the breaktank, or the spilltank will refill. All units have fixed speed pumps except "ASxAV" units which have variable speed pumps for precise pressure control.

**Quadpack – Hydro/Constant Models:** A combination of the above Dual System model with either Hydro-pneumatic booster or constant running booster.

**Single PU – Hydro/Constant Models:** A combination of the above ET45 model with either Hydro-pneumatic booster or constant running booster.

**Duty Pump Rotation.** To spread the wear evenly across all the pumps, their sequence is automatically rotated either by starting the pump that has been idle the longest and/or by timed operation (dependent upon unit type).  
Indicator lights (where fitted) on the fascia show which pump is running.

**Pumpsets with more than 4 pumps** use the <Enter> key (9) to toggle operation of the keypad and LED lights between pumps 1 to 4 and pumps 5 to 8.

Pumps 5 and over.  
Pressure ..... bar

**Automatic Restart (when “manual restart” is set to “not enabled” on 2020 Plus controller)**

If there is an interruption to the electrical supply the unit will automatically restart on restoration of the supply. Pumps will restart at timed intervals and at reduced speed dependent upon model type.

**Manual Restart (when set to “enabled” on 2020 Plus controller)**

If there is an interruption to the electrical supply, or there is a low water level condition, the unit will need to be manually reset on restoration of the supply, or low water level condition, by pressing the “Reset Alarm” key. Pumps will then restart at timed intervals and at reduced speed dependent upon model type.

**Pressure setting.** The pumpset is set at the required 'duty' pressure at the factory. If necessary, the pressure will be adjusted at commissioning to suit local conditions.

**To view the parameters**

Press <SET/VIEW> on the keypad. Now, press the same key 4 more times. Press the <UP> (7) key, to view the next parameter.

Page through the parameters by using the <UP> (7) and <DOWN> (8) keys to view:

Various parameters will be displayed dependent upon unit type. The main parameters that customers are interested in are shown below: -

Date and Time (24 hour clock)	Time 14/01/03.....22:40:15	not password protected to allow on site adjustment.
Fault Log (last 30 faults)	Fault Log	press <view> to see log followed by <up> or <down> arrows to scroll through, then press <enter> to return
Manual Restart upon power failure or low water level condition	Manual Restart Not enabled	not password protected to allow user to enable/disable
Set Tanks enabled	Set tanks enabled Tank 1 only/ 1& 2/ 2 only	not password protected to allow user to enable/disable break tank Low level & High level alarms for cleaning etc.
Pumps 1 to 8 hours run time	Pump x run time 000123.4 Hours	
Spill valve x count	Spill valve 1 count 543	number of spill valve operations
Time elapsed since last service	Since last service 000987.6 Hours	service reminder after 6 months
Total run time (power up time)	Total run time 005000.0 Hours	not resetable

Enable service call	Enable service call Enabled	enable/disable service reminder
Low pressure Lockout	LP Lockout Not Active	pump dry run/over run protection
Low pressure alarm	Low pressure 1.0 Bar	low pressure alarm. Note: low pressure approach warning is 0.2 bar more than this value
Low pressure delay	Low p delay 30 sec	time before alarm is initiated.
High pressure	High pressure 8.0 Bar	high pressure alarm. Note: high pressure approach warning is 0.2 bar below this value
High pressure delay	High p delay 10 sec	time before alarm is initiated.
Duty delay	Duty delay 0 sec	to delay duty pump starting to circulator pump pressure dips
Support delay	Support delay 10 sec	to delay support pump starting in normal operation preventing electrical/pressure dips/surges
Starts in 12 minutes	Starts/12 mns 8	sets frequency of pump starts warning (system leak detection)
Duty pressure (cold fill)	Duty pressure 5.0 bar	duty pump cut-out/cold fill pressure. All other pumps are derived from this value.
Minimum run time	Min run time 30 sec	for each pump
Maximum number of pumps to run	Max pumps to run 8	limits number of pumps allowed to run simultaneously (and therefore number of standbys)
Spill ON pressure	Spill ON offset 5.0 bar	Spill valve open (when fitted)
Spill ON/OFF differential	Spill differential 0.2 bar	Spill valve close (below ON)
Spill staging between valves	Spill staging 0.2 bar	Inter-Spill valve staging (when multiple valves fitted)



### 2.3.3 SYSTEM WARNINGS

Flashing display giving type of fault and a common warning volt free output signal on BMS enhanced models

***** Warning *****	Cause	Check
High pressure approach	system pressure at high pressure setting minus 0.2 Bar	Pressure vessel air charge wrong? Or insufficient expansion capacity?
Low pressure approach	system pressure at low pressure setting plus 0.2 Bar	Pressure vessel air charge wrong? Or water usage exceeds design capacity?
Pump starts exceeded/is system leaking?	duty pump starts exceeded "starts in 12 mins" parameter	System pipework is leaking excessively? Starts parameter set too low?
Excessive run time/ is system leaking?	duty pump continuously running for 12 minutes	System pipework is leaking excessively?
Commissioning needed	Unit has not been commissioned by authorised service engineer	Have unit commissioned by authorised service engineer.
Tank 1 Disabled	Tank 1 alarms have been disabled using controller keypad	Tank 1 alarms disabled for tank cleaning? Re-enable alarms when finished.
Tank 2 Disabled	Tank 2 alarms have been disabled using controller keypad	Tank 2 alarms disabled for tank cleaning? Re-enable alarms when finished.
Power Up	Power interruption started "Power Up" sequence	Incoming electrical supply interruption? Or missing phase? Or loose connections?
Low level delay	A low water level condition has reset, and a 4 minute delay is now initiated before normal operation will resume	Check pumps are vented and wait for the delay time to expire
Manual restart (when set to enabled)	A power interruption or low water level has occurred,	Carry out all necessary checks, then press the "Reset alarm" key on the micro

### 2.3.4 SYSTEM ALARMS

Flashing display giving type of fault, audible alarm, volt-free output signals on BMS Enhanced models, and action as described. (see below)

**RESET:** Alarms are manually muted and reset using the UP (7) or DOWN (8) buttons on the keypad. (Automatic reset facility can be provided)

***** Alarm *****	Cause	Check
Pressure system Fault	Check pumps 1 to 4, or 5 to 8 for a pump-tripped condition. (by pressing <Enter> key)	Check electrical supply is within tolerance, or missing phase? Pump seized? motor failed? Variable speed drive/inverter trip? Motor thermistor overheated?
High pressure	system pressure at/above high pressure setting & delay timer expired	Pressure vessel air charge wrong? Or insufficient expansion capacity? Pump(s) left in Hand?
Low pressure	system pressure at/below low pressure setting & delay timer expired	Pressure vessel air charge wrong? Or water usage exceeds design capacity? Pump(s) switched Off or Tripped?
Transducer failed	Pressure sensor output above normal range of pressure sensor or pressure sensor not connected correctly.	Pressure higher than sensor range? Or pressure sensor failed? Or pressure sensor wiring loose?
Pump overload fault	Pump/Inverter tripped signal present	Check electrical supply is within tolerance, or missing phase? Pump seized? motor failed? Motor thermistor overheated?
No water in feed tank	water level below supply tank low water alarm probe or pipework sensor dry. (240 second delay on automatic restart, after restoration of water level).	Break tank float valve stuck closed? Or output of pumpset exceeds mains water supply into break tank? Mains water interruption to break tank?
Pump overheated	Pump motor temperature too high.	Pump seized? motor failed? Motor thermistor overheated?
High water level Tank 1 or 2	water level above supply tank high water alarm probe	Break tank float valve wrongly adjusted, stuck open or letting by?
Low pressure lockout/ please vent the pumps	system pressure remained at or below low pressure setting for duration of low pressure delay timer, and lock out protection is invoked.	Pumps are air locked and need venting? Or running off end of curve due to demand beyond design limit? Pump(s) switched Off or Tripped?
Low water level Tank 1 or 2	water level below supply tank low water alarm probe or pipework sensor dry. (240 second delay on automatic restart, after restoration of water level).	Break tank float valve stuck closed? Or output of pumpset exceeds mains water supply into break tank? Mains water interruption to break tank?
Other Fault	Hardware shutdown	Please call AquaTech-Pressmain for advice

**If a problem persists contact AQUATECH-PRESSMAIN LIMITED quoting the serial number WN:\_\_\_\_\_ (on control panel fascia)**

**REMOTE SIGNALS on BMS Enhanced models only**

- volt free contacts in control panel (see fig 1.3) :

High system pressure	Pump tripped/failed
Low system pressure	Transducer failed
High/Low Water level in breaktank	Common warning
Excessive pump starts (Aquapack units only)	Boiler/chiller cut-out

**RESETTING PARAMETERS**

The parameters are protected from inadvertent alteration by a security code. They may be reset on site by an Aquatech-Pressmain Service engineer.

**SERVICING REMINDER**

When routine service is due display gives telephone no. to call  
This can be deactivated if required.

System O.K./routine service due/ for maintenance call/ AquaTech Pressmain Ltd U.K. 01206 215121
--

**If a problem persists contact AQUATECH-PRESSMAIN service department quoting the serial number WN:\_\_\_\_\_ (on control panel fascia)**

## 2.4 MAINTENANCE INSTRUCTIONS

### FOR PRESSURISATION UNIT models with 2020Plus CONTROLLER:

#### READ GENERAL SAFETY INFORMATION 0.0, WARNINGS 0.1 and CAUTIONS 0.2, 0.3 & 0.4

#### 2.4.1. ADDITIONAL CAUTIONS

2.4.1.1. On AS2ET-N models ensure an adequate Nitrogen supply is maintained to the control vessel whilst operating.

#### 2.4.2 PROCEDURE

Every 6 months the unit should be maintained by authorised AquaTech-Pressmain service agents -see Servicing (Section 3)

##### Pump Lubrication

The pumps require no lubrication, as the pumps are self-lubricating.

##### Expansion, Control and Hydro Accumulator vessels

- Air Charge Pressure.** The correct charge pressure provides reliable operation of the system and a prolonged lifetime of the diaphragm. This should be checked regularly. To adjust: isolate the vessel from the system and release pressure on water side by opening the drain cock disposing of the water mix in the appropriate manner. The water inside the bladder will be pushed back by the air charge pressure. Remove cap on the filling valve, set air charge pressure refilling using dry air or nitrogen. Screw cap firmly on filling valve. Close the drain cock and open water connection to the system.
- Replacement of the diaphragm** (except for 8 litre vessels where the complete vessel is replaced). Isolate vessel from the system and drain water from vessel using drain cock disposing of the water mix in the appropriate manner. Release air charge. Remove water connection flange A. Release diaphragm support B by removing cap F and nut C on dished end D. Remove diaphragm E from inside the bottom opening. Check vessel for dirt, corrosion etc., remove or flush with water. The diaphragms are not oil resistant and oily liquids must not be used to protect the inside surfaces of tanks against corrosion. The vessel should be dry when replacing diaphragm. Put support B in new diaphragm and pass a flexible cord through the hole in support B, securing it on the underside. Roll up diaphragm in the longitudinal axis and pull the diaphragm by means of the cord into the vessel as far as the fixing opening in the top, then remove rope. Secure support B by fitting washer U and nut C. Fit cap F on top of B and close vessel by replacing flange A. Recharge with dry air or nitrogen as above. Check vessel for leaks and reconnect to the system.

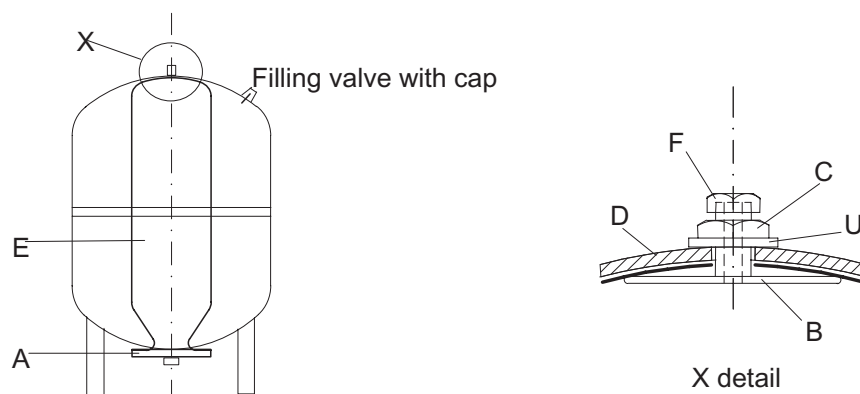

**LEAVE EQUIPMENT WITH ALL PUMPS SWITCHES IN THE AUTO POSITION,  
THE MAINS SUPPLY SWITCHED ON,  
AND THE SYSTEM CONNECTION OPEN**

## 3. SERVICING

### 3.1 MAINTENANCE AND CARE OF YOUR EQUIPMENT

The AquaTech-Pressmain equipment that is described in this instruction booklet has been manufactured and tested to the highest standards of design and quality. It will give trouble free operation over many years provided it is maintained regularly from when it is commissioned. To keep it operating efficiently in a safe, economical and environmentally friendly condition, regular maintenance is an essential part.

AquaTech-Pressmain Limited along with its' sister company, and fellow AGM Group member, Acorn Pressurisation Services Ltd are the official providers of commissioning and maintenance services. (see below).

Several companies operating under the Aquatronic Group Management structure are available to fulfil a wide range of servicing and maintenance requirements, as detailed below.

### 3.2 LEGAL REQUIREMENTS

Hydraulic Accumulators/Expansion Vessels installed as part of/in conjunction with this equipment, with Pressure x Volume above 250 Bar-litres, require formal inspection in accordance with a "Written Scheme of Examination". This is a Legal Requirement on the part of the Owner/User under the "Pressure Systems Safety Regulations" (PSSR). A "Written Scheme" and regular inspection can be provided by either Acorn Pressurisation Services (combined maintenance and inspection) or ESIS Ltd (inspection only), see details below.

#### Plant Servicing & Inspection



**ACORN PRESSURISATION SERVICES LIMITED,**  
**AGM House, Essex, CO6 1GT. Ph: 01206 215151**  
**130 Princess Rd, Manchester, M16 7BY. 0161 226 4727**

Acorn provides maintenance and installation of all types of packaged water pumping equipment for building services. Its specialist fields are Pressure booster equipment and sealed systems for heating and chilled water distribution systems.

Regular servicing of any plant for essential services is vital because wear and tear are very gradual processes. With preventative maintenance, the costs are small and benefits in reliability, safety and economy can be significant. Acorn Pressurisation Services Ltd can provide a complete package of schemes for preventative maintenance on all AquaTech-Pressmain and other makes of equipment.

#### Pressure Vessel Inspection



**ESIS ENGINEERING SAFETY & INSPECTION SERVICES LTD,**  
**AGM House, London Rd, Copford, Colchester, Essex, CO6 1GT.**  
**Phone: 01206 215141 Fax: 01206 215142**

Under the Pressure Systems Safety Regulations, expansion vessels and hydraulic accumulators, generally 250 bar-litres and greater, and protection devices, require a Written Scheme of Examination before they can be operated. ESIS Inspection and Insurance Services Limited specifications can provide the means to comply with these regulations. These services can be extended to cover other units e.g. air pressure receivers etc.

### 3.3 SERVICE CONTACTS

**For service during warranty period contact: AQUATECH-PRESSMAIN Service Department**

**Head Office Tel: 01206 215121**

**Manchester Office Tel: 0161 226 4727**

**For regular servicing, contact their service agents: ACORN PRESSURISATION SERVICES LTD**

**Head Office Tel: 01206 215151**

**Manchester Office Tel: 0161 226 4727**

who will be pleased to give you expert advice on this or any other servicing matter.



## 4. DISPOSAL

Disposal of this product or parts of it must be carried out in accordance with the following guidelines:

- 4.1 Use the local public or private recycling/waste collection service.  
 4.2 In case such a recycling/waste collection service does not exist or cannot handle the materials used in this product, please deliver the product or any hazardous material from it to your nearest AquaTech-Pressmain office.

### **EC Declaration of Conformity**

We, Aquatech-Pressmain Limited, declare this Pressure Equipment Assembly:

#### PRESSURISATION UNIT

**MODEL :** Aquapack (1-4) ET  
 Spillpress SP(1-4)  
 Aquaspill SA10-E, GV-E, TA-E, AS (1-4)  
 Nitropack AS (1-4) N

Complies with the following standards:

**BS EN 60204-1:2006**  
**EN61000-6-3:2001, EN61000-6-1:2001**

and meets the requirements of EEC Directives:

**Pressure Equipment Directive 97/23/EC (PED)**  
**Low Voltage Directive 73/23/EEC and 93/68/EEC**  
**Electro Magnetic Compatability Directive 89/336/EEC with amendments**  
**92/31/EEC.**

**PED Conformity Assessment Modules : B + D**

**Notified Body : BSI Product Services,**  
**Maylands Avenue**  
**Hemel Hempstead**  
**Hertfordshire**  
**HP2 4SQ**

**Type Examination Certificate Ref. CE95657**



30.07.2005

I.D. Taylor, I.Eng. MIET, Director, AquaTech-Pressmain Limited.

#### **AquaTech-Pressmain Limited**

AGM House, London Rd, Copford, Colchester, Essex CO6 1GT UK  
 Telephone: 01206 215121 Fax: 01206 215131

Notes...

# OPERATING PARAMETERS

**SERIAL No.** ..... **MODEL**.....

THE SERIAL & MODEL NUMBERS MUST BE QUOTED WHEN REQUESTING ASSISTANCE

**ELECTRICAL DATA:**

Supply ..... volts ..... Ph ..... Hz

Full load current of pumpset ..... Amps

Max. unit loading: ..... Kw Method of starting: .....

**NOISE LEVEL:** less than 70 db(A) unless otherwise stated .....

**PRESSURE SETTINGS:**

**AS FACTORY SET**

	bar		secs
Duty pressure (cold fill)	.....	Duty pump delay	.....
Support pump cut-in	.....	Support pump delay	.....
High Pressure	.....	High pressure delay	.....
Low pressure	.....	Low pressure delay	.....
Spill valve cut-in pressure	.....		
Expansion vessel cushion pressure.	.....		
Control/Nitrogen vessel cushion pressure	.....		

❖ AMENDED AT COMMISSIONING	
bar	secs
.....	.....
.....	.....
.....	.....
.....	.....
.....	.....
.....	.....
.....	.....

❖ On commissioning it may be found necessary to modify these settings. Providing this information is left with the equipment, the figures will be updated by the commissioning engineer.

Updated by commissioning engineer ..... Date .....